

Oblique Basin



Image shows Model HBOBL-533-1-W
Oblique Basin with one tap hole
and white powder coat finish

Scan QR code
to view our
installation notes

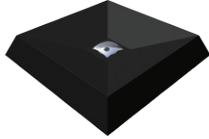

Image shows Model HBOBL-457-B
Oblique Basin in black powder coat finish

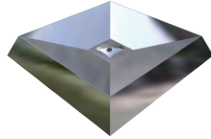

Image shows Model HBOBL-457-SS
Oblique Basin in stainless finish

HBOBL-457 HBOBL-533

To order this item please advise:

- Code: HBOBL-457 (without tap hob) or HBOBL-533 (with tap hob)
- Finish: stainless, black or white
- No of tap holes (for HBOBL-533 only)
- Tapware details if applicable

Product Info:

- Ultra modern, sleek profile
- Hand made, seamless construction
- Satin finish stainless steel
- Optional black or white powder coat
- 40mm waste with square cover supplied
- Models with and without tap landing

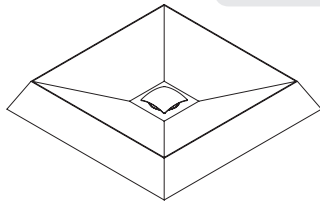

MODEL HBOBL-457

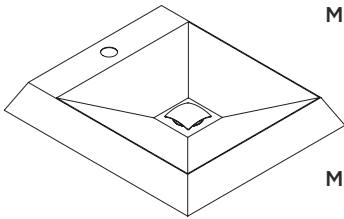

MODEL HBOBL-533

INSTALLATION NOTES

1) Penetrations in bench top will need to be provided to connect waste outlet and, if model HBOBL-533, for tapware. 2) A silicon or adhesive tape (not supplied) should be applied to the underside of the flange to fix basin to bench top and then caulked around external perimeter for water sealing.

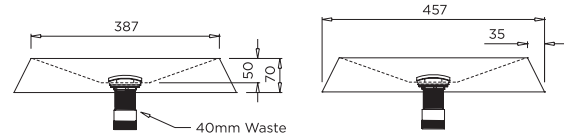

MODEL HBOBL-457 Front and Side Elevation

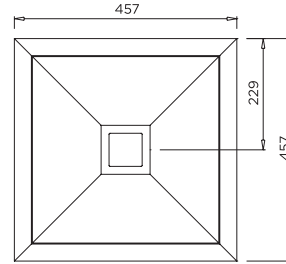

MODEL HBOBL-457 Plan

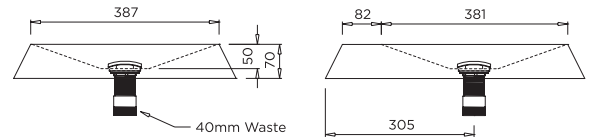

MODEL HBOBL-533 Front and Side Elevation

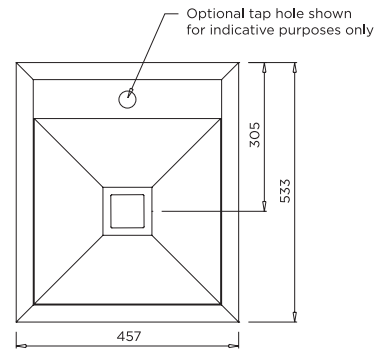

MODEL HBOBL-533 Plan